



Freestanding Basin

BA050112



SPECIFICATIONS

500*400*850mm

With internal overflow

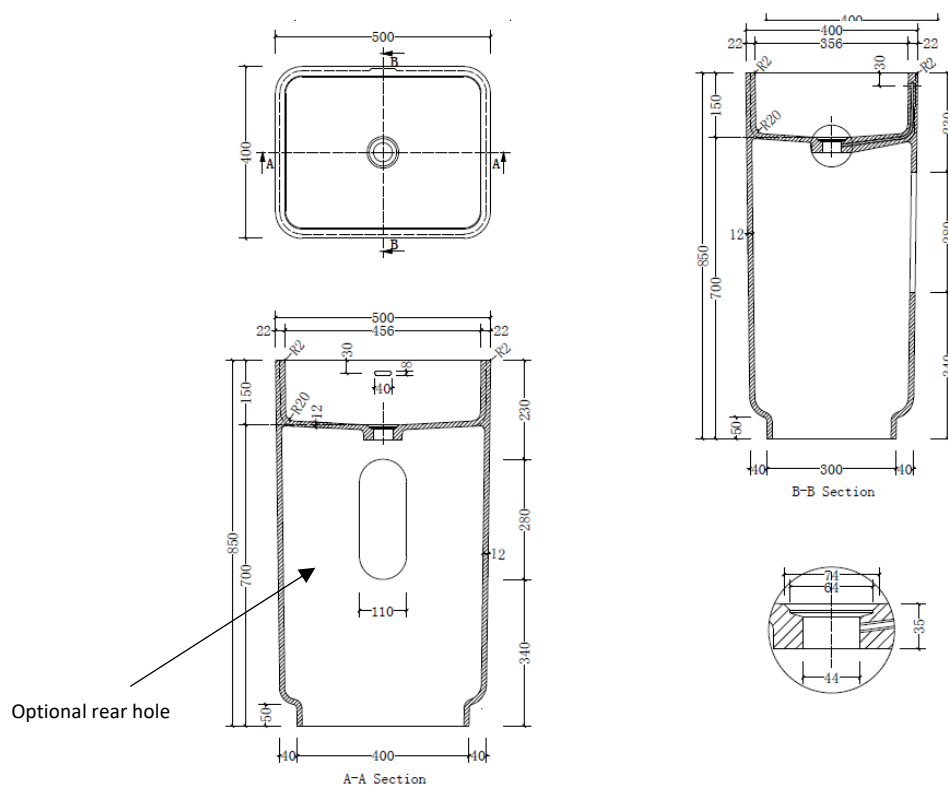

*Dimensional tolerances are applied to meet design requirements and tailor-made needs for customers.
*All dimensions are subject to the final mutually approved document.